

**User
Manual**

APPA 701/703

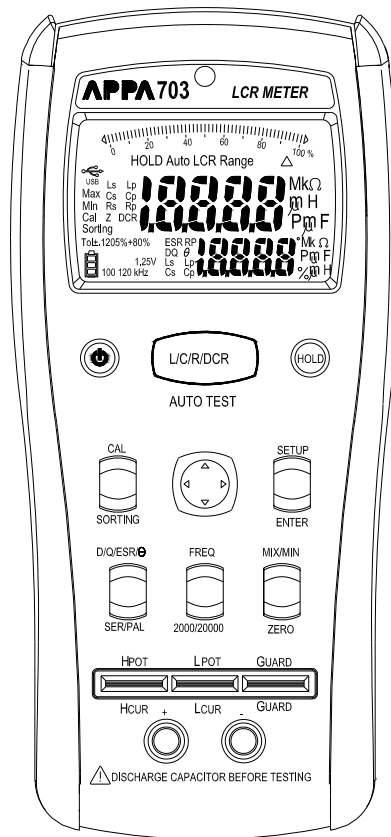

CE

APPA

Advanced Instrument Technology Made Easy

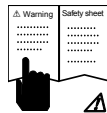

⚠ Read First

⚠ Safety Information

Understand and follow operating instructions carefully. Use the meter only as specified in this manual; otherwise, the protection provided by the meter may be impaired.

⚠ WARNING

Identifies hazardous conditions and actions that could cause **BODILY HARM** or **DEATH**

⚠ CAUTION

Identifies conditions and actions that could **DAMAGE** the meter or equipment under test









⚠ WARNING

- When using test leads or probes, keep your fingers behind the finger guards.
- Remove test lead from Meter before opening the battery door or Meter case.
- Use the Meter only as specified in this manual or the protection by the Meter might be impaired.
- Always use proper terminals, switch position, and range for measurements.
- Do not apply more than the rated voltage, as marked on Meter, between terminals or between any terminal and earth ground.
- Use caution with voltages above 30 Vac rms, 42 Vac peak, or 60 Vdc. These voltages pose a shock hazard.
- To avoid false readings that can lead to electric shock and injury, replace battery as soon as low battery indicator.
- Discharge all high-voltage capacitors before testing.
- Do not use Meter around explosive gas or vapor.
- To reduce the risk of fire or electric shock do not expose this product to rain or moisture.

⚠ CAUTION

- Never connect a source of voltage that could result in damage the meter and the equipment under test.
- Do not expose Meter to extremes in temperature or high humidity.

Symbols as marked on the Meter and Instruction manual

	Risk of electric shock
	See instruction manual
	DC measurement
	Battery
	Fuse
	Earth
	AC measurement
	Conforms to EU directives
	Do not discard this product or throw away.

Maintenance

Do not attempt to repair this Meter. It contains no userserviceable parts. Repair or servicing should only be performed by qualified personnel.

Cleaning

Periodically wipe the case with a dry cloth and detergent. Do not use abrasives or solvents.

The Meter Description

Front Panel Illustration

1. LCD display : 20000/2000 counts .
2. Function buttons.
3. 5-Wire input terminal for SMD test probe or DIP part.
4. 2-Wire input terminal for Alligator Clip.

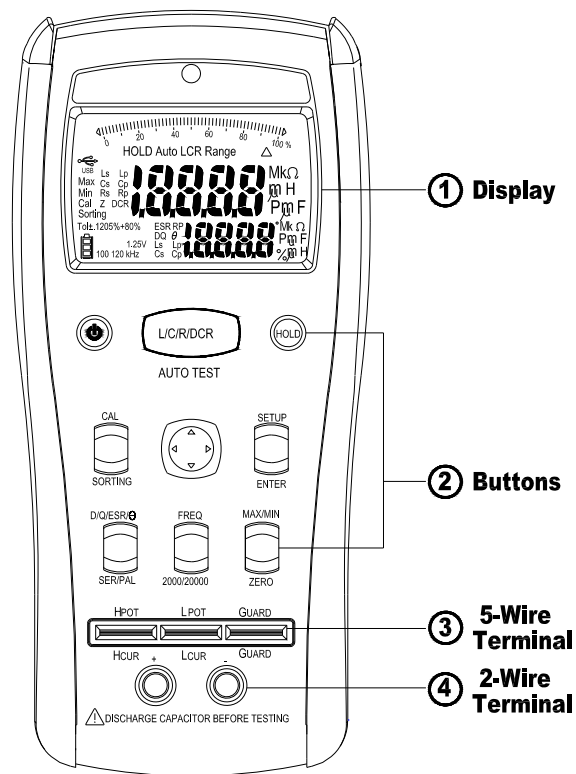

The assembly

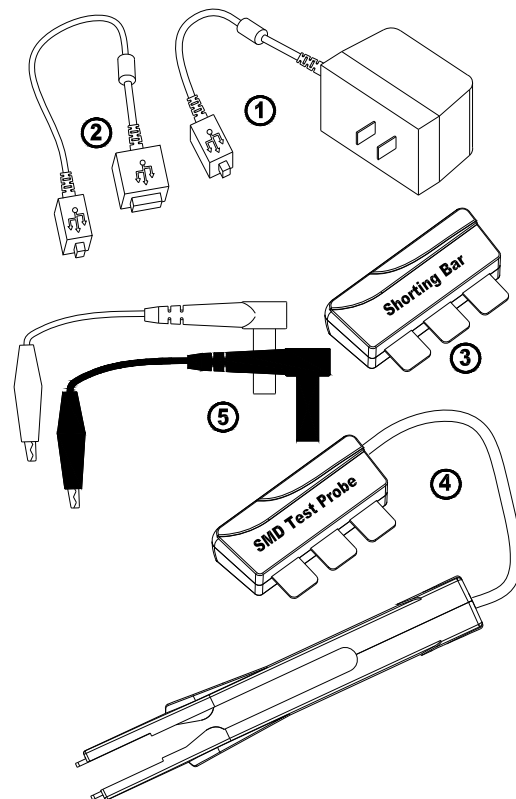

1. 5V AC Adapter (only APPA 703)
2. USB Cable (only APPA 703)
3. Shorting Bar
4. SMD Test Probe (only APPA 703)
5. Alligator Clip Set.

Measuring Principle

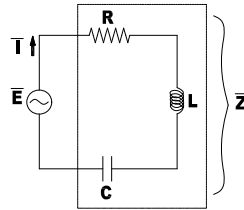

$$\bar{E} = R + j(X_L - X_C)$$

$$\bar{Z} = \sqrt{R^2 + (X_L - X_C)^2} \leq \tan^{-1} \left(\frac{X_L - X_C}{R} \right)$$

$$X_L = 2\pi fL = \omega L$$

$$X_C = \frac{1}{2\pi fC} = \frac{1}{\omega C}$$

$$\theta = \tan^{-1} \left(\frac{X_L - X_C}{R} \right)$$

$$Q = \frac{1}{D} = \tan \theta$$

Series Measuring

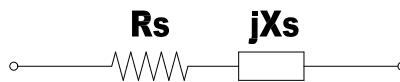

$$Z = R_s + jX_s$$

Parallel Measuring

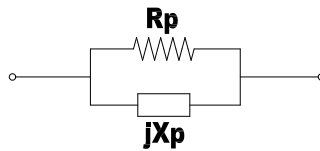

$$Y = \frac{1}{R_p} + \frac{1}{jX_p}$$

Phase Drawing

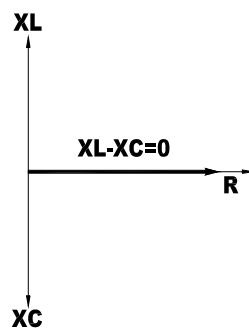
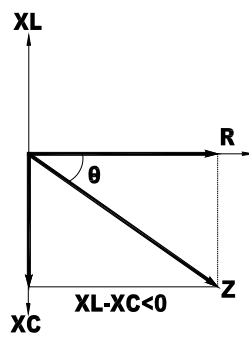
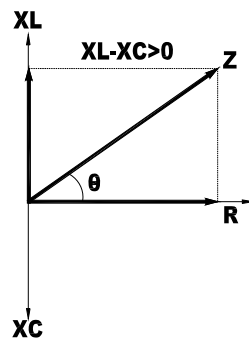

Making 5-wire measuring with the SMD test probe

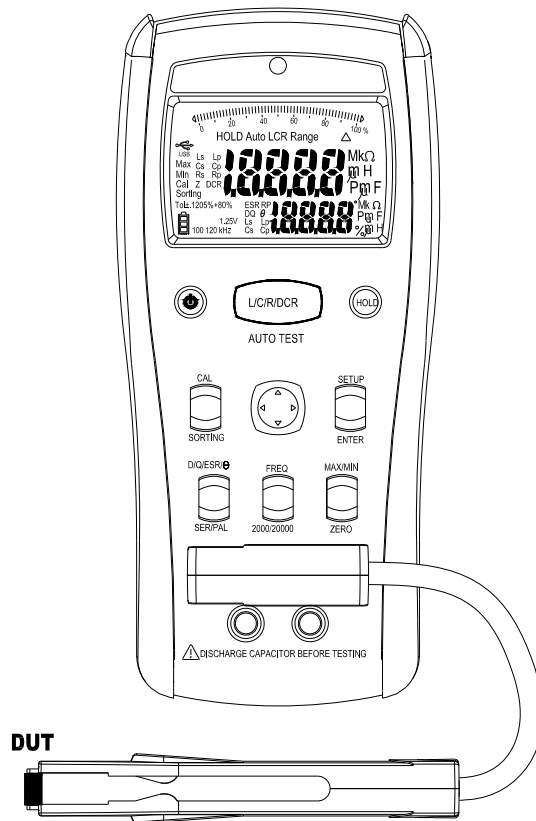

Making 4-wire measuring in the 5-wire terminal

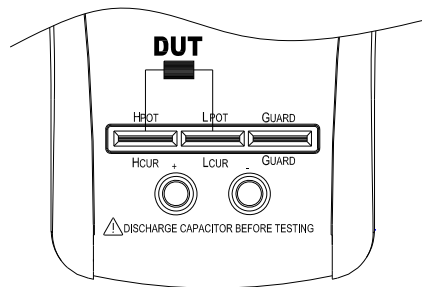

Making 2-wire measuring with the alligator clip set

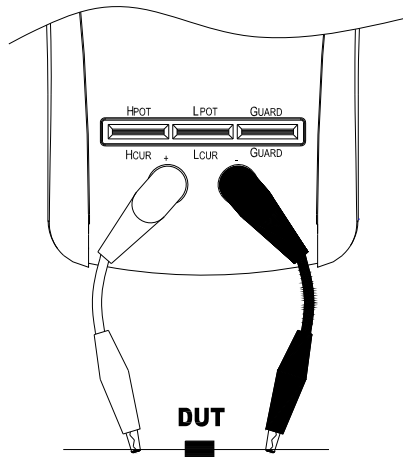

Measuring L/C/R/DCR

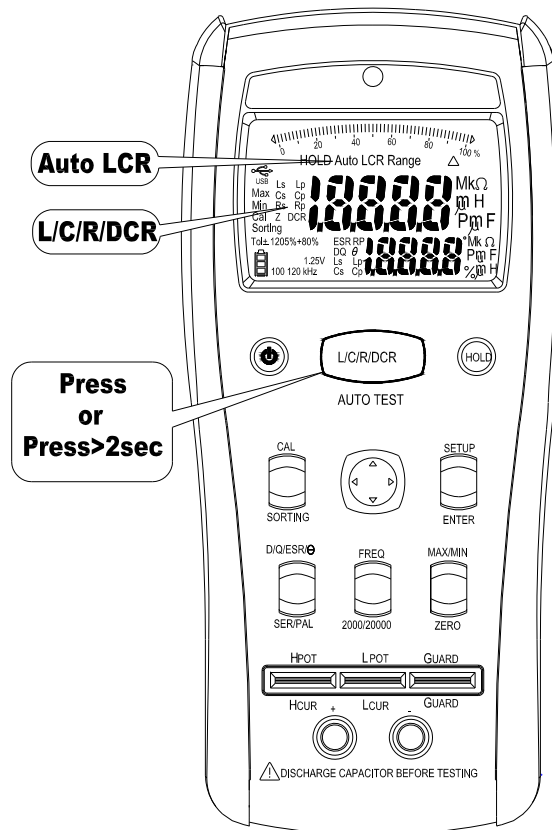

- Press the L/C/R/DCR button to select the measuring function.
- Press the L/C/R/DCR button for 2 seconds to enter the Auto L/C/R function.

Measuring D/Q/ESR/ θ

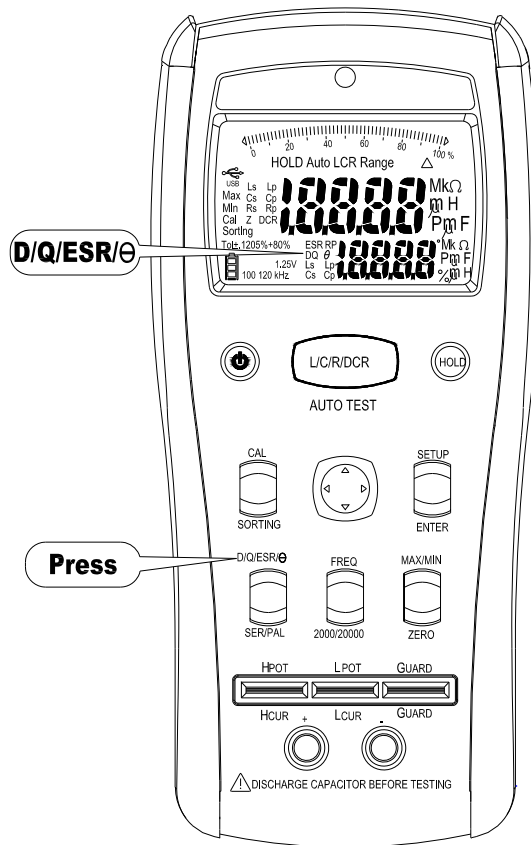

- Press the D/Q/ESR/ θ button to select the measuring function.
- The θ function is only at APPA 703.

Select test Frequency

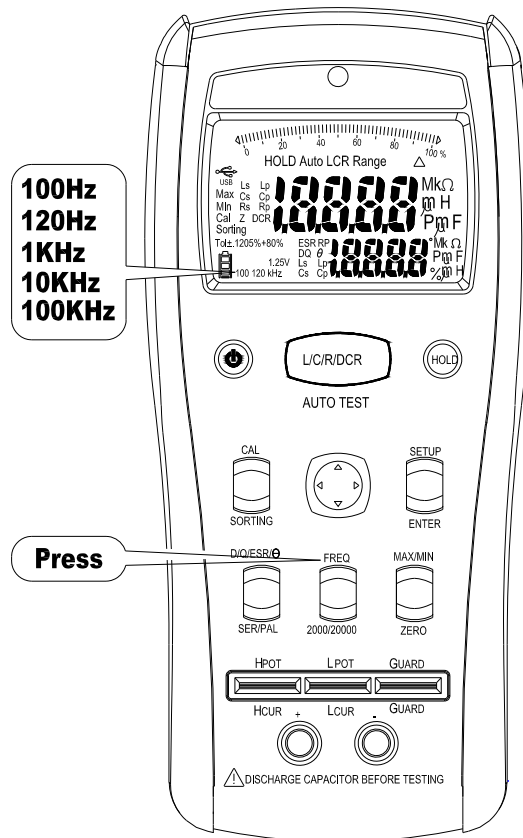

- Press the FREQ button to select the test frequency.
- The 100KHz test frequency is only at APPA 703.

Select Series / Parallel measuring function

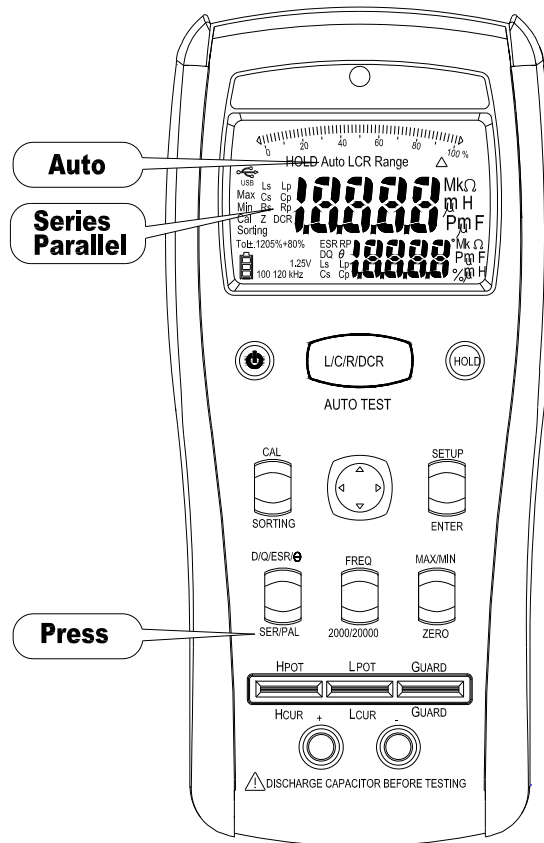

- At the L/C/R measuring function, it defaults to Auto Series / Parallel measuring function.
- Press the SER/PAL button to select the measuring function.

Select Display Count

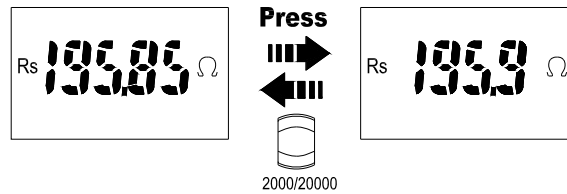

- Press the 2000 /20000 button to select the display count.

Zero

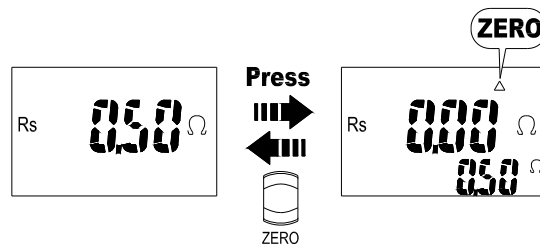

The Zero mode records the current input value as reference and appears on the sub display. The after input values will subtract the reference value and display on the main display. To use the Zero mode, follow the steps below.

1. Press the Zero button to enter Zero mode. The "Δ" appears on the display.
2. Press the Zero button again to record a new input value as reference.
3. Press the Zero button for 2 seconds to exit this mode.

Display Hold

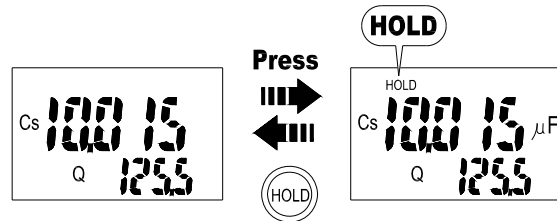

- Press the HOLD button to hold the reading of the meter, press the button again to return.

Display MAX/MIN

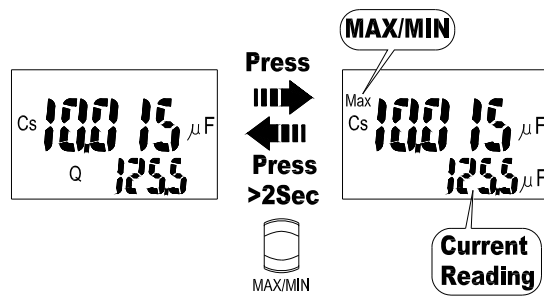

The MAX/MIN mode records the maximum and the minimum input values. When the inputs go below the recorded minimum value or above the recorded maximum value, the meter beeps and records the new value.

To use the MAX/MIN mode, follow the steps below.

1. Press the MAX/MIN button to enter the MAX/MIN mode.
The "MAX" appears on the display, the maximum value on the main display and the current value on the sub display.
2. Press the MAX/MIN button to select the MAX or MIN display.
3. Press the MAX/MIN button for 2 seconds to exit this mode.

Note : This function is only at APPA 703.

Calibrate

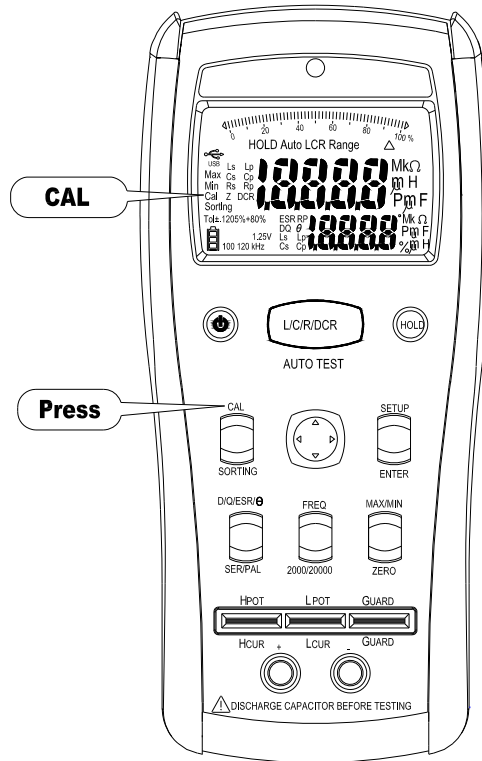

In order to achieve the best measuring result, calibration is must. To calibrate the meter, press the CAL button.

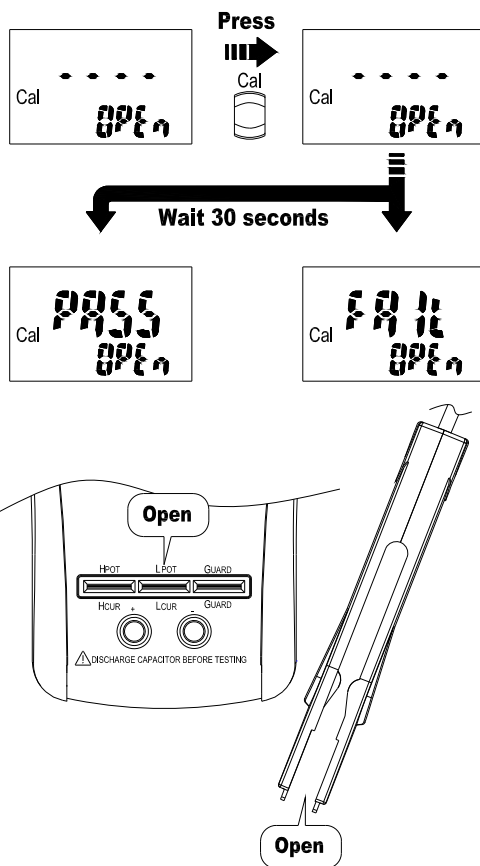

When "OPEn" appears on the sub display, make the terminal or the SMD test probe open, and press the CAL button to start open calibration. About 30 seconds later, the result of the open calibration appears on the main display. If the result is pass, press the CAL button to next step. If the result is fail, press the CAL button to exit the function.

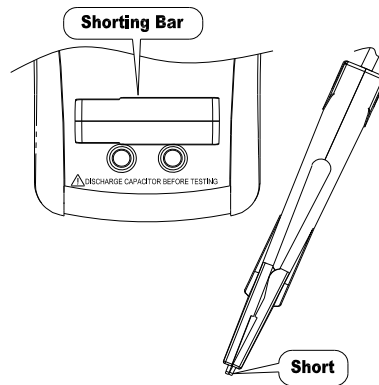
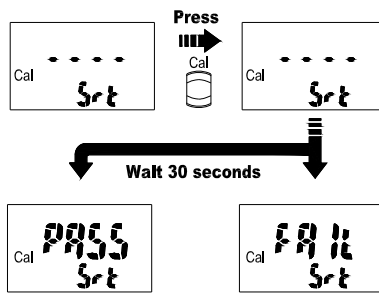

When "Srt" appears on the sub display, make the terminal or the SMD test probe short, and press the CAL button to start short calibration. About 30 seconds later, the result of the short calibration appears on the main display. If the result is pass, press the CAL button to complete the calibration. If the result is fail, press the CAL button to exit the function.

Sorting

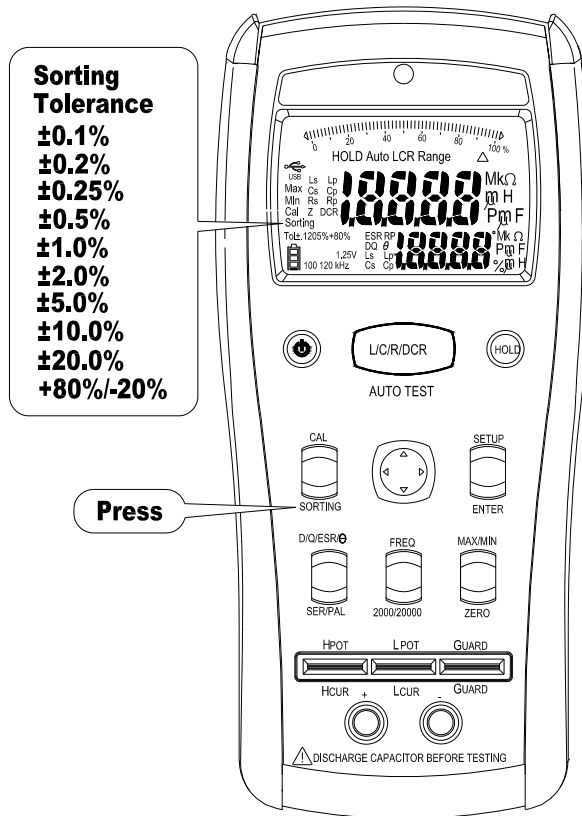

To check the accuracy of the part, press the SORTING button to enter the sorting mode. The sorting result appears on the main display, and the current value appears on the sub display.

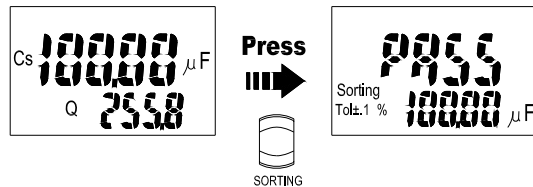

The default sorting standard value is the current value, and the default tolerance is $\pm 1.0\%$.

Setup Sorting Standard

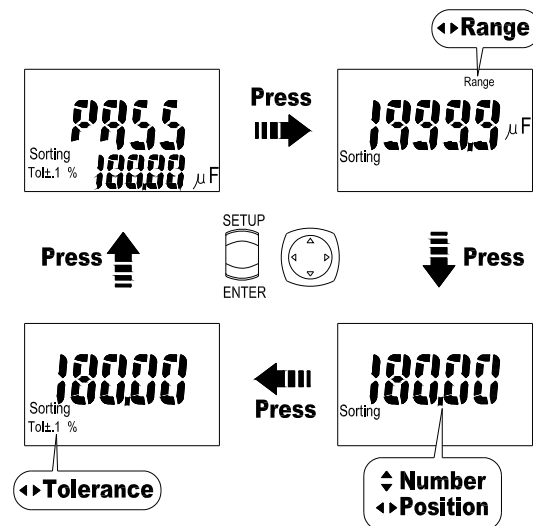

To setup the sorting standard value, follow the steps below.

1. Press the SETUP button to enter the setup mode.
2. Press \triangleleft and \triangleright button to setup the range of the standard value. Then press the ENTER button to save the setup value and enter the next step.
3. Press \triangle , ∇ , \triangleleft and \triangleright button to setup the standard value. Then press the ENTER button to save the setup value and enter the next step.
4. Press \triangleleft and \triangleright button to setup the tolerance value. Then press the ENTER button to save the setup value and exit this mode.

Battery Replacement

Refer to the following figure to replace the batteries :

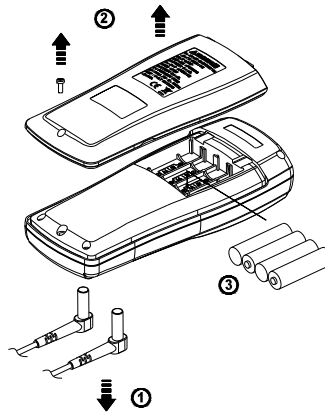

⚠ Caution

- Replace the batteries as soon as the low batteries indicator  appears, to avoid false reading.
- 1.5V x 4 alkaline batteries.

External Power Source

To save the batteries power by using the external power source.

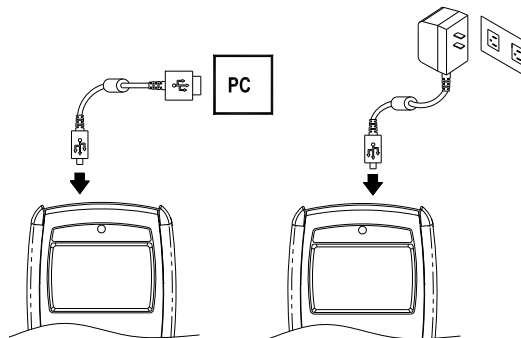

⚠ Caution

- Use the 5V AC adapter only as specified in this manual.
- Do not apply the other source connect to the meter.

Specifications

General Specifications

Maximum voltage applied to any terminal :

30V_{DC} or 30V_{AC} rms

Display : 2000/20000 counts

Overrange Indication : OL

Batteries Life : 50 hours

Low Batteries Indication : "  " is displayed when the batteries voltage drops below operating voltage.

Low battery voltage : Approx. 4.5V

Auto Power Off : 10 minutes.

Operating Ambient : Non-condensing $\leq 10^{\circ}\text{C}$,

11 $^{\circ}\text{C}$ ~ 30 $^{\circ}\text{C}$ ($\leq 80\%$ RH),

30 $^{\circ}\text{C}$ ~ 40 $^{\circ}\text{C}$ ($\leq 75\%$ RH),

40 $^{\circ}\text{C}$ ~ 50 $^{\circ}\text{C}$ ($\leq 45\%$ RH)

Storage Temperature :

-20 $^{\circ}\text{C}$ to 60 $^{\circ}\text{C}$, 0 to 80% R.H. (batteries not fitted)

Temperature Coefficient :

0.15 x (Spec.Accy) / $^{\circ}\text{C}$, < 18 $^{\circ}\text{C}$ or > 28 $^{\circ}\text{C}$.

Measure : Samples 1.25 times per second normal.

Altitude : 6561.7 ft (2000m)

Weight : (630g) including battery.

Dimensions (W x H x D) :

95mm x 207mm x 52mm with holster.

Accessories :

Battery (installed), Test leads and User manual.

(The probe assembly provided with the product are for use with meter)

Power Requirements : 1.5V x 4 IEC LR6 or AA size.

Pollution Degree : 2

Safety : Complies with EN 61010-1, IEC 61010-1

EMC : EN 61326-1

Shock Vibration : Sinusoidal vibration per MIL-T- 28800E

(5 ~ 55 Hz, 3g maximum).

Drop Protection : 4 feet drop to hardwood on concrete floor.

Indoor Use.

Electrical Specifications

(1) Test Frequency :

Range	Resolution	Accuracy
100.00 Hz	0.01 Hz	± 0.01%
120.00 Hz	0.01 Hz	± 0.01%
1.0000 kHz	0.1 Hz	± 0.01%
10.000 kHz	1 Hz	± 0.01%
100.00 kHz	10 Hz	± 0.01%

(2) Test Signal :

AC Signal Level : 600mVrms
AC Signal Accuracy : ±10%
DC Bias Level : 1V
DC Bias Accuracy : ±10%

(3) Test Cable :

Model	Length	Bandwidth	Type
SMD Test Probe	60cm	1MHz	5-Wire
4-Wire Test Probe	60cm	1MHz	5-Wire
Alligator Clip Set	15cm	1kHz	2-Wire

Accuracy : ± (A x B) (% of reading)

A : Basic Accuracy as specified by

B : Test Cable Accuracy

$B(\%) = 1 + (L \times F \times T)$

L(m) : Cable Length

F(MHz) : Test Frequency

T : Cable Type. If the cable is 5-Wire type, the "T" is 40, and the other is 4,000.

When measuring by basic accuracy that following conditions must be met :

1. Ambient temperature : 23°C ± 5°C < 80%RH.
2. Test cable length : 0 m
3. Open and short corrections have been performed.
4. $D \leq 0.1$ for C, L measurements; $Q \leq 0.1$ for R measurements.

See the operation manual for additional conditions.

(4) Inductance

Frequency	Range	Accuracy
100Hz 120Hz	20.000mH	$\pm (0.5\% + 5d)^{[2]}$
	200.00mH	$\pm (0.2\% + 5d)$
	2000.0mH	
	20.000H	
	200.00H	$\pm (0.5\% + 5d)$
	2000.0H	$\pm (1.0\% + 5d)^{[2]}$
1KHz	2000.0uH	$\pm (0.5\% + 5d)^{[2]}$
	20.000mH	$\pm (0.2\% + 5d)$
	200.00mH	
	2000.0mH	
	20.000H	$\pm (0.5\% + 5d)$
	200.00H	$\pm (1.0\% + 5d)^{[2]}$
10KHz	200.00uH	$\pm (0.5\% + 5d)^{[2]}$
	2000.0uH	$\pm (0.2\% + 5d)$
	20.000mH	
	200.00mH	$\pm (2.0\% + 5d)$
	2000.0mH	$\pm (5.0\% + 5d)$
100KHz ^[1]	20.000uH	$\pm (0.5\% + 5d)^{[2]}$
	200.00uH	$\pm (0.2\% + 5d)$
	2000.0uH	
	20.000mH	$\pm (2.0\% + 5d)$
	200.00mH	$\pm (5.0\% + 5d)$

[1] The 100KHz test frequency is only at APPA 703.

[2] The measuring time is 2 seconds.

Input Protection : 30V_{DC} or 30V_{AC} rms

Minimum Resolution : 0.001uH in the 20.000uH range.

Measuring Time : 800ms

2-wire Accuracy : Add 1.0% to accuracy.

Note : If $D > 0.1$, the accuracy should be multiplied by $\sqrt{1 + D^2}$

(5) Capacitance

Frequency	Range	Accuracy
100Hz 120Hz	2000.0pF	$\pm (0.5\% + 5d)^{[2]}$
	20.000nF	$\pm (0.2\% + 5d)$
	200.00nF	
	2000.0nF	
	20.000uF	$\pm (0.5\% + 5d)$
	200.00uF	$\pm (1.0\% + 5d)$
	2000.0uF	$\pm (2.0\% + 5d)^{[2]}$
1KHz	2000.0pF	$\pm (0.5\% + 5d)^{[2]}$
	20.000nF	$\pm (0.2\% + 5d)$
	200.00nF	
	2000.0nF	
	20.000uF	$\pm (0.5\% + 5d)$
	200.00uF	$\pm (1.0\% + 5d)$
	2000.0uF	$\pm (2.0\% + 5d)^{[2]}$
10KHz	200.00pF	$\pm (0.5\% + 5d)^{[2]}$
	2000.0pF	$\pm (0.2\% + 5d)$
	20.000nF	
	200.00nF	
	2000.0nF	$\pm (0.5\% + 5d)$
	20.000uF	$\pm (2.0\% + 5d)$
200.00uF	$\pm (5.0\% + 5d)^{[2]}$	
100KHz ^[1]	20.000pF	$\pm (0.5\% + 20d)^{[2]}$
	200.00pF	$\pm (0.2\% + 5d)$
	2000.0pF	
	20.000nF	
	200.00nF	$\pm (0.5\% + 5d)$
	2000.0nF	$\pm (2.0\% + 5d)$
20.000uF	$\pm (5.0\% + 5d)^{[2]}$	

[1] The 100KHz test frequency is only at APPA 703.

[2] The measuring time is 2 seconds.

Input Protection : 30V_{DC} or 30V_{AC} rms

Minimum Resolution : 0.001pF in the 20.000pF range.

Measuring Time : 800ms

2-wire Accuracy : Add 1.0% to accuracy.

Note : If $D > 0.1$, the accuracy should be multiplied by $\sqrt{1 + D^2}$

(6) Resistance

Frequency	Range	Accuracy
100Hz 120Hz	200.00Ω	± (0.2% + 5d)
	2.0000KΩ	
	20.000KΩ	
	200.00KΩ	
	2.0000MΩ	
	20.000MΩ	± (0.5% + 5d)
1KHz	200.00MΩ	± (1.0% + 5d) ^[2]
	20.000Ω	± (0.5% + 15d) ^[2]
	200.00Ω	± (0.2% + 5d)
	2.0000KΩ	
	20.000KΩ	
	200.00KΩ	
	2.0000MΩ	
	20.000MΩ	± (2.0% + 5d)
200.00MΩ	± (5.0% + 5d) ^[2]	
10KHz	20.000Ω	± (0.5% + 15d) ^[2]
	200.00Ω	± (0.2% + 5d)
	2.0000KΩ	
	20.000KΩ	
	200.00KΩ	
	2.0000MΩ	± (2.0% + 5d)
20.000MΩ	± (5.0% + 5d)	
100KHz ^[1]	20.000Ω	± (0.5% + 15d) ^[2]
	200.00Ω	± (0.2% + 5d)
	2.0000KΩ	
	20.000KΩ	
	200.00KΩ	± (2.0% + 5d)
	2.0000MΩ	± (5.0% + 5d)

[1] The 100KHz test frequency is only at APPA 703.

[2] The measuring time is 2 seconds.

Input Protection : 30V_{DC} or 30V_{AC} rms

Minimum Resolution : 0.001Ω in the 20.000Ω range.

Measuring Time : 800ms

2-wire Accuracy : Add 1.0% to accuracy.

Note : If $Q > 0.1$, the accuracy should be multiplied by $\sqrt{1+Q^2}$

(7) DCR

Range	Resolution	Accuracy
200.00Ω	0.01Ω	± (0.2% + 5d)
2.0000KΩ	0.0001KΩ	
20.000KΩ	0.001KΩ	
200.00KΩ	0.01KΩ	
2.0000MΩ	0.0001MΩ	
20.000MΩ	0.001MΩ	± (0.5% + 5d)
200.00MΩ	0.01MΩ	± (1.0% + 5d) ^[1]
[1] < 50dgt rolling.		

Input Protection : 30V_{DC} or 30V_{AC} rms

Minimum Resolution : 0.01Ω in the 200.00Ω range.

Measuring Time : 2 seconds

2-wire Accuracy : Add 1.0% to accuracy.

(8) D & Q

Definition Q=1/D

Range : 2.000 ~ 2000

Minimum Resolution : 0.001 in the 2.000 range.

Accuracy : Accuracy of Main Reading x (1+D)

Input Protection : 30V_{DC} or 30V_{AC} rms

2-wire Accuracy : Add 1.0% to accuracy.

(9) ESR :

The specification of ESR is same as Resistance.

(10) θ :

Range	Resolution	Accuracy
-90.0° ~ 90.0°	0.1°	± (0.2% + 5d)

Input Protection : 30V_{DC} or 30V_{AC} rms

2-wire Accuracy : Add 1.0% to accuracy.

Note : The θ function is only at APPA 703.

Limited Warranty

This meter is warranted to the original purchaser against defects in material and workmanship for 2 years from the date of purchase. During this warranty period, Manufacturer will, at its option, replace or repair the defective unit, subject to verification of the defect or malfunction.

This warranty does not cover Carlos fuses, disposable batteries, or damage from abuse, neglect, accident, unauthorized repair, alteration, contamination, or abnormal conditions of operation or handling.

Any implied warranties arising out of the sale of this product, including but not limited to implied warranties of merchantability and fitness for a particular purpose, are limited to the above.

The manufacturer shall not be liable for loss of use of the instrument or other incidental or consequential damages, expenses, or economic loss, or for any claim or claims for such damage, expense or economic loss. Some states or countries laws vary, so the above limitations or exclusions may not apply to you.

