

# Geberit Mapress Stainless Steel

---

	Description
<b>Geberit Mapress pipes</b>	<ul style="list-style-type: none"><li>• Pipes → Page 120</li></ul>
<b>Geberit Mapress fittings</b>	<ul style="list-style-type: none"><li>• Bends with plain ends → Page 120</li><li>• Couplings → Page 122</li><li>• Bends → Page 123</li><li>• Pipe bridges → Page 125</li><li>• Reducers → Page 125</li><li>• T-pieces → Page 126</li><li>• Adapters → Page 130</li><li>• Elbow adapters → Page 131</li><li>• Connectors → Page 132</li><li>• Adapter unions → Page 133</li><li>• Straight unions → Page 136</li><li>• Flanges → Page 136</li><li>• Expansion fittings → Page 138</li><li>• Stop valves → Page 138</li><li>• Ball valves → Page 140</li><li>• Bulkhead and deck passings → Page 140</li><li>• Closures → Page 140</li></ul>



### System pipes

#### Geberit Mapress system pipe CrNiMo-steel (small bundle)

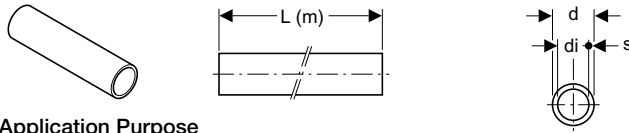

##### Application Purpose

- For sanitary, gas and industrial applications

##### Characteristics

- Corrosion-resistant
- Noncombustible, combustible substance class A1 in acc. with DIN 4102-1

##### Product Details

Product material	CrNiMo steel 1.4401 (DIN EN 10088)
Thermal expansion	0.016 mm/(m·K)
Thermal conductivity of pipe	15 W/(m·K)
Surface roughness	1.5 µm

##### Scope Of Delivery

- Delivery in sections
- Small bundle

##### Ordering Information

Article no.	dØ [mm]	diØ [mm]	s [mm]	L (m) [m]
39202	15	13	1	6
39203	18	16	1	6
39204	22	19,6	1,2	6
39205	28	25,6	1,2	6
39206	35	32	1,5	6
39207	42	39	1,5	6
39208	54	51	1,5	6
39209	76,1	72,1	2	6
39210	88,9	84,9	2	6
39211	108	104	2	6

#### Geberit Mapress system pipe CrNiMo-steel (large bundle)

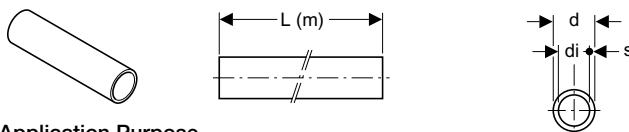

##### Application Purpose

- For sanitary, gas and industrial applications

##### Characteristics

- Corrosion-resistant
- Noncombustible, combustible substance class A1 in acc. with DIN 4102-1

##### Product Details

Product material	CrNiMo steel 1.4401 (DIN EN 10088)
Thermal expansion	0.016 mm/(m·K)
Thermal conductivity of pipe	15 W/(m·K)
Surface roughness	1.5 µm

##### Scope Of Delivery

- Delivery in sections
- Large bundle

##### Ordering Information

Article no.	dØ [mm]	diØ [mm]	s [mm]	L (m) [m]
39002	15	13	1	6
39003	18	16	1	6
39004	22	19,6	1,2	6
39005	28	25,6	1,2	6
39006	35	32	1,5	6
39007	42	39	1,5	6
39008	54	51	1,5	6
39009	76,1	72,1	2	6
39010	88,9	84,9	2	6
39011	108	104	2	6

### Bends with plain ends

#### Geberit Mapress bend 90° with plain ends

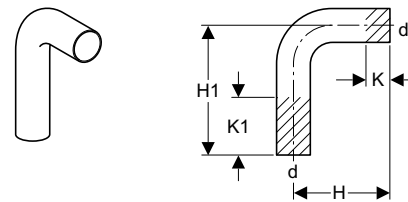

##### Application Purpose

- For sanitary and industrial applications
- For heating installations
- For gas installations with natural gases (NG) and liquefied gases (LPG)

##### Product Details

Product material	CrNiMo steel 1.4401 (DIN EN 10088)
Elbow	90°

##### Ordering Information

Article no.	dØ [mm]	H [cm]	H1 [cm]	K [cm]	K1 [cm]
30402	15	7	12	2,2	7,2
30403	18	7	12	1,7	6,7
30404	22	7	12	0	5
30405	28	8	12	0	4
30406	35	12	20	2	10
30407	42	15	25	3	13
30408	54	20	30	5,5	15,5
30089	new 76,1	16,6	28,6	0	12
30090	new 88,9	19,4	31,9	0	12,5
30091	new 108	24	37,7	0	13,7

Bends with plain ends

**Geberit Mapress bend 60° with plain ends**

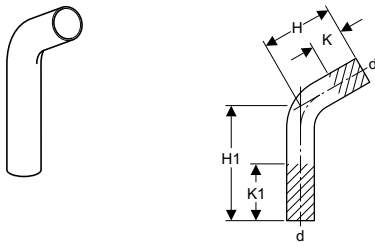

**Application Purpose**

- For sanitary and industrial applications
- For heating installations
- For gas installations with natural gases (NG) and liquefied gases (LPG)

**Product Details**

Product material	CrNiMo steel 1.4401 (DIN EN 10088)
Elbow	60°

**Ordering Information**

Article no.	dØ [mm]	H [cm]	H1 [cm]	K [cm]	K1 [cm]
30942	15	6	12,2	2,1	8,3
30943	18	6,2	12,2	1,6	7,6
30944	22	6	11,8	0,5	6,3
30955	28	6,3	12,1	0	5,8
30956	35	9,7	20,3	2	12,6
30957	42	12	25,6	3	16,6
30958	54	16,2	30,6	5,5	19,9
30069	new 76,1	12,6	24,6	0	12
30070	new 88,9	14,6	27,1	0	12,5
30071	new 108	18	31,7	0	13,7

**Geberit Mapress bend 45° with plain ends**

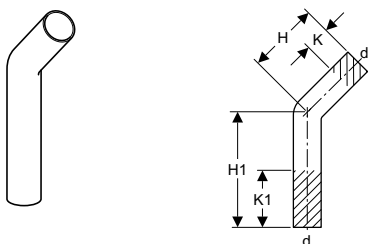

**Application Purpose**

- For sanitary and industrial applications
- For heating installations
- For gas installations with natural gases (NG) and liquefied gases (LPG)

**Product Details**

Product material	CrNiMo steel 1.4401 (DIN EN 10088)
Elbow	45°

**Ordering Information**

Article no.	dØ [mm]	H [cm]	H1 [cm]	K [cm]	K1 [cm]
30872	15	6,2	12	1,9	7,7
30873	18	5,8	12,4	1,6	8,2
30874	22	5,6	12	0,7	7,1
30875	28	5,8	12,2	0,2	6,6

Article no.	dØ [mm]	H [cm]	H1 [cm]	K [cm]	K1 [cm]
30876	35	9,4	20,6	2	13,2
30877	42	11,4	26,2	0,1	14,9
30878	54	14,6	32,1	3,7	21,2
30049	new 76,1	11,1	23	0	11,9
30050	new 88,9	13	25,2	0	12,2
30051	new 108	15,7	29,4	0	13,7

**Geberit Mapress bend 30° with plain ends**

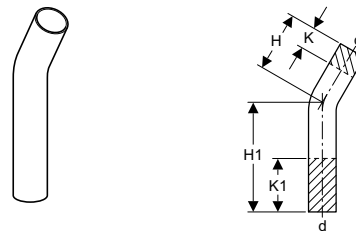

**Application Purpose**

- For sanitary and industrial applications
- For heating installations
- For gas installations with natural gases (NG) and liquefied gases (LPG)

**Product Details**

Product material	CrNiMo steel 1.4401 (DIN EN 10088)
Elbow	30°

**Ordering Information**

Article no.	dØ [mm]	H [cm]	H1 [cm]	K [cm]	K1 [cm]
30932	15	6	12,2	2,1	8,3
30933	18	5,5	12,8	1,6	8,9
30934	22	5	12,4	0,6	8
30935	28	5,1	13	0	7,9
30936	35	8	21,4	2	15,4
30937	42	9,9	27,2	3	20,3
30938	54	13,4	32,6	5,5	24,7
30029	new 76,1	9,7	21,7	0	12
30030	new 88,9	11,1	23,6	0	12,5
30031	new 108	13,6	27,3	0	13,7



### Geberit Mapress bend 15° with plain ends

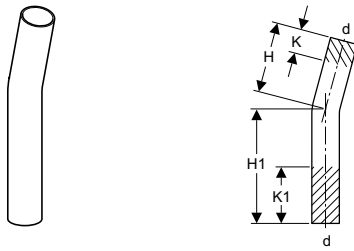

#### Application Purpose

- For sanitary and industrial applications
- For heating installations
- For gas installations with natural gases (NG) and liquefied gases (LPG)

#### Product Details

Product material	CrNiMo steel 1.4401 (DIN EN 10088)
Elbow	15°

#### Ordering Information

Article no.	dØ [mm]	H [cm]	H1 [cm]	K [cm]	K1 [cm]
30892	15	6	12,2	2,1	8,3
30893	18	5,5	12,8	1,5	8,8
30894	22	5	12,4	0,7	8,1
30905	28	4,5	13,4	0	8,9
30906	35	7,3	22,2	2	16,9
30907	42	8,9	28	3	22,1
30908	54	12,2	33,7	4,5	26
30009	new 76,1	8,4	20,4	0	12
30010	new 88,9	9,5	22	0	12,5
30011	new 108	11,7	25,4	0	13,7

## Couplings

### Geberit Mapress coupling



#### Application Purpose

- For sanitary and industrial applications
- For heating installations

#### Characteristics

- Leaky if unpressed
- With pressing indicator

#### Product Details

Product material	CrNiMo steel 1.4401 (DIN EN 10088)
------------------	------------------------------------

#### Scope Of Delivery

- Seal rings CIIR black

#### Ordering Information

Article no.	dØ [mm]	L [cm]	Z [cm]
32002	15	4,8	0,8
32003	18	4,8	0,8

Article no.	dØ [mm]	L [cm]	Z [cm]
32004	22	5	0,8
32005	28	5,4	0,8
32006	35	6,2	1
32007	42	7,1	1,1
32008	54	8,3	1,3
32009	76,1	14,1	3,5
32010	88,9	16,2	4,2
32011	108	19,4	4,4

### Geberit Mapress slip coupling



#### Application Purpose

- For sanitary and industrial applications
- For heating installations

#### Characteristics

- Leaky if unpressed
- With pressing indicator

#### Product Details

Product material	CrNiMo steel 1.4401 (DIN EN 10088)
------------------	------------------------------------

#### Scope Of Delivery

- Seal rings CIIR black

#### Ordering Information

Article no.	dØ [mm]	E [cm]	L [cm]	Z [cm]
32102	15	2,5	8	3
32103	18	2,5	8	3
32104	22	2,5	8,4	3,4
32105	28	3	9,1	3,1
32106	35	3	10,2	4,2
32107	42	4	12	4
32108	54	4	14	6
32109	76,1	6	23	11
32110	88,9	7	26	12
32111	108	8	31	15

**Bends**

**Geberit Mapress bend 90°**

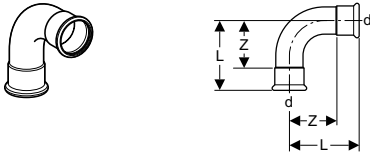

**Application Purpose**

- For sanitary and industrial applications
- For heating installations

**Characteristics**

- Leaky if unpressed
- With pressing indicator

**Product Details**

Product material	CrNiMo steel 1.4401 (DIN EN 10088)
Elbow	90°

**Scope Of Delivery**

- Seal rings CIIR black

**Ordering Information**

Article no.	dØ [mm]	L [cm]	Z [cm]
30102	15	4,9	2,9
30103	18	5,3	3,3
30104	22	6,1	4
30105	28	7,2	4,9
31106	35	6,8	4,2
31107	42	8	5
31108	54	10	6,5
31109	76,1	15,3	10
31110	88,9	17,9	11,9
31111	108	22,2	14,7

**Geberit Mapress bend 90° with plain end**

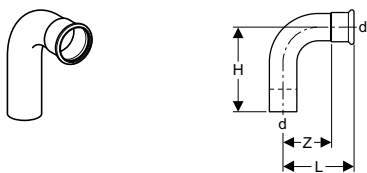

**Application Purpose**

- For sanitary and industrial applications
- For heating installations

**Characteristics**

- Plain end
- Leaky if unpressed
- With pressing indicator

**Product Details**

Product material	CrNiMo steel 1.4401 (DIN EN 10088)
Elbow	90°

**Scope Of Delivery**

- Seal ring CIIR black

**Ordering Information**

Article no.	dØ [mm]	H [cm]	L [cm]	Z [cm]
30302	15	5,9	4,9	2,9
30303	18	6,1	5,3	3,3
30304	22	7	6,1	4
30305	28	7,9	7,2	4,9
33306	35	7,7	6,8	4,2
33307	42	9	8	5
33308	54	11,1	10	6,5
33309	76,1	16,6	15,3	10
33310	88,9	19,4	17,9	11,9
33311	108	24	22,2	14,7

**Geberit Mapress bend 60°**

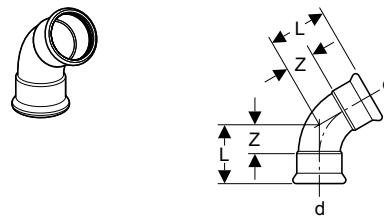

**Application Purpose**

- For sanitary and industrial applications
- For heating installations

**Characteristics**

- Leaky if unpressed
- With pressing indicator

**Product Details**

Product material	CrNiMo steel 1.4401 (DIN EN 10088)
Elbow	60°

**Scope Of Delivery**

- Seal rings CIIR black

**Ordering Information**

Article no.	dØ [mm]	L [cm]	Z [cm]
36161	15	4	2
36163	22	4,7	2,6
36164	28	5,4	3,1
36165	35	5	2,4
36166	42	5,9	2,9
36167	54	7,2	3,7
36168	76,1	11,3	6
36169	88,9	13,1	7,1
36170	108	16,2	8,7



### Geberit Mapress bend 45°

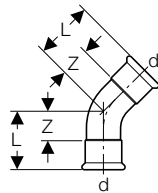

#### Application Purpose

- For sanitary and industrial applications
- For heating installations

#### Characteristics

- Leaky if unpressed
- With pressing indicator

#### Product Details

Product material	CrNiMo steel 1.4401 (DIN EN 10088)
Elbow	45°

#### Scope Of Delivery

- Seal rings CIIR black

#### Ordering Information

Article no.	dØ [mm]	L [cm]	Z [cm]
30602	15	3,6	1,6
30603	18	3,7	1,7
30604	22	4,2	2,1
30605	28	4,8	2,5
32606	35	4,3	1,7
32607	42	5,1	2,1
32608	54	6,2	2,7
32609	76,1	9,7	4,4
32610	88,9	11,2	5,2
32611	108	13,9	6,4

### Geberit Mapress bend 45° with plain end

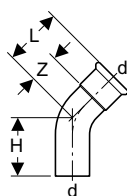

#### Application Purpose

- For sanitary and industrial applications
- For heating installations

#### Characteristics

- Plain end
- Leaky if unpressed
- With pressing indicator

#### Product Details

Product material	CrNiMo steel 1.4401 (DIN EN 10088)
Elbow	45°

#### Scope Of Delivery

- Seal ring CIIR black

#### Ordering Information

Article no.	dØ [mm]	H [cm]	L [cm]	Z [cm]
30702	15	4,5	3,6	1,6
30703	18	4,2	3,7	1,7
30704	22	5,2	4,2	2,1
30705	28	5,6	4,8	2,5
32706	35	5,3	4,3	1,7
32707	42	6,1	5,1	2,1
32708	54	7,3	6,2	2,7
32709	76,1	11,1	9,7	4,4
32710	88,9	13	11,2	5,2
32711	108	15,7	13,9	6,4

### Geberit Mapress bend 30°

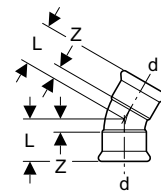

#### Application Purpose

- For sanitary and industrial applications
- For heating installations

#### Characteristics

- With pressing indicator
- Leaky if unpressed

#### Product Details

Product material	CrNiMo steel 1.4401 (DIN EN 10088)
Elbow	30°

#### Scope Of Delivery

- Seal rings CIIR black

#### Ordering Information

Article no.	dØ [mm]	L [cm]	Z [cm]
36121	15	3,3	1,3
36123	22	3,7	1,6
36124	28	4,1	1,8
36125	35	3,7	1,1
36126	42	4,4	1,4
36127	54	5,2	1,7
36128	76,1	8,4	3,1
36129	88,9	9,6	3,6
36130	108	11,8	4,3

### Geberit Mapress bend 15°

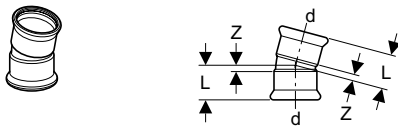

#### Characteristics

- With pressing indicator
- Leaky if unpressed

#### Product Details

Product material	CrNiMo steel 1.4401 (DIN EN 10088)
Elbow	15°

#### Scope Of Delivery

- Seal rings CIIR black

#### Ordering Information

Article no.	dØ [mm]	L [cm]	Z [cm]
36101	15	3	1
36103	22	3,3	1,2
36104	28	3,6	1,3
36105	35	3,2	0,6
36106	42	3,7	0,7
36107	54	4,4	0,9
36108	76,1	7,1	1,8
36109	88,9	8	2
36110	108	9,9	2,4

## Pipe bridges

### Geberit Mapress pipe bridge

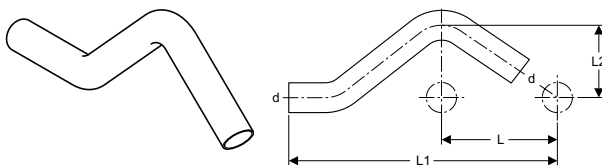

#### Application Purpose

- For sanitary and industrial applications
- For heating installations
- For gas installations with natural gases (NG) and liquefied gases (LPG)

#### Characteristics

- For parallel pipes with distance L

#### Product Details

Product material	CrNiMo steel 1.4401 (DIN EN 10088)
------------------	------------------------------------

#### Ordering Information

Article no.	dØ [mm]	L [cm]	L1 [cm]	L2 [cm]
30802	15	5,7	15,8	3,7
30803	18	6	16,5	4
30804	22	6,5	17,8	4,4
30805	28	7,4	21	5

## Reducers

### Geberit Mapress reducer with plain end

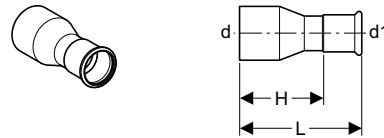

#### Application Purpose

- For sanitary and industrial applications
- For heating installations

#### Characteristics

- Plain end
- Leaky if unpressed
- With pressing indicator

#### Product Details

Product material	CrNiMo steel 1.4401 (DIN EN 10088)
------------------	------------------------------------

#### Scope Of Delivery

- Seal ring CIIR black

#### Ordering Information

Article no.	dØ [mm]	d1Ø [mm]	H [cm]	L [cm]
32303	18	15	3,5	5,5
32305	22	15	3,9	5,9
32306	22	18	3,7	5,7
32307	28	15	4,6	6,6
32308	28	18	4,4	6,4
32309	28	22	3,9	6
32310	35	15	5,5	7,5
32311	35	18	5,4	7,4
32312	35	22	5	7,1
32313	35	28	4,5	6,8
32314	42	15	6,1	8,1
32315	42	18	6	8
32316	42	22	6,1	8,2
32317	42	28	6	8,3
32318	42	35	5,1	7,7
32319	54	15	7,7	9,7
32320	54	18	7,6	9,6
32321	54	22	7,4	9,5
32322	54	28	8,7	11
32323	54	35	8	10,6
32324	54	42	6,2	9,2
32331	76,1	54	11,1	14,6
32338	88,9	54	12,8	16,3
32339	88,9	76,1	10,8	16,1
32345	108	54	13,7	17,2
32346	108	76,1	13,1	18,4
32348	108	88,9	14,3	20,3



## T-pieces

### Geberit Mapress T-piece equal

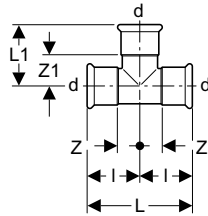

#### Application Purpose

- For sanitary and industrial applications
- For heating installations

#### Characteristics

- Leaky if unpressed
- With pressing indicator

#### Product Details

Product material	CrNiMo steel 1.4401 (DIN EN 10088)
Elbow	90°

#### Scope Of Delivery

- Seal rings CIIR black

#### Ordering Information

Article no.	dØ [mm]	L [cm]	L1 [cm]	l [cm]	Z [cm]	Z1 [cm]
31002	15	6,4	3,9	3,2	1,2	1,9
31003	18	6,8	4,1	3,4	1,4	2,1
31004	22	7,4	4,4	3,7	1,6	2,3
31005	28	8,4	5	4,2	1,9	2,7
31006	35	10	5,7	5	2,4	3,1
31007	42	11,4	6,5	5,7	2,7	3,5
31008	54	13,8	7,7	6,9	3,4	4,2
31009	76,1	23	11	11,5	6,2	5,7
31010	88,9	26	12,8	13	7	6,8
31011	108	31	15,3	15,5	8	7,8

### Geberit Mapress T-piece reduced

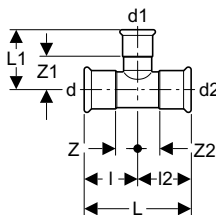

#### Application Purpose

- For sanitary and industrial applications
- For heating installations

#### Characteristics

- Reduced
- Leaky if unpressed
- With pressing indicator

#### Product Details

Product material	CrNiMo steel 1.4401 (DIN EN 10088)
Elbow	90°

#### Scope Of Delivery

- Seal rings CIIR black

Ordering Information

Article no.	dØ [mm]	d1Ø [mm]	d2Ø [mm]	L [cm]	L1 [cm]	l [cm]	l2 [cm]	Z [cm]	Z1 [cm]	Z2 [cm]
31208	18	15	15	7,9	4,1	3,4	4,5	1,4	2,1	2,5
31204	18	15	18	6,8	4,1	3,4	3,4	1,4	2,1	1,4
31227	22	15	18	8,5	4,3	3,7	4,8	1,6	2,3	2,8
31206	22	15	22	7,4	4,3	3,7	3,7	1,6	2,3	1,6
31228	22	18	18	8,5	4,3	3,7	4,8	1,6	2,3	2,8
31207	22	18	22	7,4	4,3	3,7	3,7	1,6	2,3	1,6
31209	28	15	28	8,4	4,6	4,2	4,2	1,9	2,6	1,9
31210	28	18	28	8,4	4,6	4,2	4,2	1,9	2,6	1,9
31234	28	22	22	9	4,7	4,2	4,8	1,9	2,6	2,7
31211	28	22	28	8,4	4,7	4,2	4,2	1,9	2,6	1,9
31212	35	15	35	10	4,9	5	5	2,4	2,9	2,4
31213	35	18	35	10	4,9	5	5	2,4	2,9	2,4
31235	35	22	28	10,4	5	5	5,4	2,4	2,9	3,1
31214	35	22	35	10	5	5	5	2,4	2,9	2,4
31242	35	28	28	10,4	5,3	5	5,4	2,4	3	3,1
31215	35	28	35	10	5,3	5	5	2,4	3	2,4
31216	42	15	42	11,4	5,3	5,7	5,7	2,7	3,3	2,7
31217	42	18	42	11,4	5,3	5,7	5,7	2,7	3,3	2,7
31243	42	22	35	11,5	5,4	5,7	5,8	2,7	3,3	3,2
31218	42	22	42	11,4	5,4	5,7	5,7	2,7	3,3	2,7
31251	42	28	35	11,5	5,7	5,7	5,8	2,7	3,4	3,2
31219	42	28	42	11,4	5,7	5,7	5,7	2,7	3,4	2,7
31220	42	35	42	11,4	6,1	5,7	5,7	2,7	3,5	2,7
31221	54	15	54	13,8	5,9	6,9	6,9	3,4	3,9	3,4
31222	54	18	54	13,8	5,9	6,9	6,9	3,4	3,9	3,4
31223	54	22	54	13,8	6	6,9	6,9	3,4	3,9	3,4
31224	54	28	54	13,8	6,3	6,9	6,9	3,4	4	3,4
31225	54	35	54	13,8	6,7	6,9	6,9	3,4	4,1	3,4
31226	54	42	54	13,8	7,1	6,9	6,9	3,4	4,1	3,4
31229	76,1	22	76,1	23	7,7	11,5	11,5	6,2	5,6	6,2
31230	76,1	28	76,1	23	7,9	11,5	11,5	6,2	5,6	6,2
31231	76,1	35	76,1	23	8,1	11,5	11,5	6,2	5,5	6,2
31232	76,1	42	76,1	23	8,1	11,5	11,5	6,2	5,1	6,2
31233	76,1	54	76,1	23	8,7	11,5	11,5	6,2	5,2	6,2
31236	88,9	22	88,9	26	8,5	13	13	7	6,4	7
31237	88,9	28	88,9	26	8,7	13	13	7	6,4	7
31238	88,9	35	88,9	26	9	13	13	7	6,4	7
31239	88,9	42	88,9	26	9,2	13	13	7	6,2	7
31240	88,9	54	88,9	26	9,3	13	13	7	5,8	7
31241	88,9	76,1	88,9	26	11,4	13	13	7	6,1	7
31244	108	22	108	31	10,3	15,5	15,5	8	8,2	8
31245	108	28	108	31	10,5	15,5	15,5	8	8,2	8
31246	108	35	108	31	10,8	15,5	15,5	8	8,2	8
31247	108	42	108	31	11	15,5	15,5	8	8	8
31248	108	54	108	31	11,3	15,5	15,5	8	7,8	8
31249	108	76,1	108	31	12,4	15,5	15,5	8	7,1	8
31250	108	88,9	108	31	13,5	15,5	15,5	8	7,5	8



## Geberit Mapress T-piece with female thread

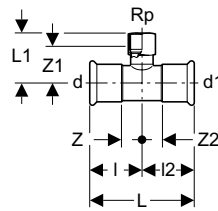

### Application Purpose

- For sanitary and industrial applications
- For heating installations

### Characteristics

- Female thread
- Leaky if unpressed
- With pressing indicator

### Product Details

Product material	CrNiMo steel 1.4401 (DIN EN 10088)
Elbow	90°

### Scope Of Delivery

- Seal rings CIIR black

### Ordering Information

Article no.	dØ [mm]	Rp ["]	d1Ø [mm]	L [cm]	L1 [cm]	l [cm]	l2 [cm]	Z [cm]	Z1 [cm]	Z2 [cm]
31304	15	1/2	15	6,4	4	3,2	3,2	1,2	2,7	1,2
31305	18	1/2	18	6,8	4,2	3,4	3,4	1,4	2,9	1,4
31306	18	3/4	18	6,8	4,4	3,4	3,4	1,4	2,9	1,4
31307	22	1/2	22	7,4	4,3	3,7	3,7	1,6	3	1,6
31308	22	3/4	22	7,4	4,6	3,7	3,7	1,6	3,1	1,6
31309	28	1/2	28	8,4	4,6	4,2	4,2	1,9	3,3	1,9
31310	28	3/4	28	8,4	4,9	4,2	4,2	1,9	3,4	1,9
31311	28	1	28	8,4	5,3	4,2	4,2	1,9	3,6	1,9
31312	35	1/2	35	10	5	5	5	2,4	3,7	2,4
31313	35	3/4	35	10	5,3	5	5	2,4	3,8	2,4
31316	42	1/2	42	11,4	5,3	5,7	5,7	2,7	4	2,7
31317	42	3/4	42	11,4	5,6	5,7	5,7	2,7	4,1	2,7
31320	54	1/2	54	13,8	5,9	6,9	6,9	3,4	4,6	3,4
31321	54	3/4	54	13,8	6,2	6,9	6,9	3,4	4,7	3,4
31324	54	2	54	13,8	7,9	6,9	6,9	3,4	5,6	3,4
31326	76,1	3/4	76,1	23	7,9	11,5	11,5	6,2	6,4	6,2
31329	76,1	2	76,1	23	8,9	11,5	11,5	6,2	6,6	6,2
31331	88,9	3/4	88,9	26	8,8	13	13	7	7,3	7
31334	88,9	2	88,9	26	9,6	13	13	7	7,3	7
31336	108	3/4	108	31	10,5	15,5	15,5	8	9	8
31339	108	2	108	31	11,5	15,5	15,5	8	9,2	8

## Geberit Mapress T-piece with male thread

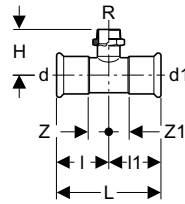

## Application Purpose

- For sanitary and industrial applications
- For heating installations

## Characteristics

- Male thread
- Leaky if unpressed
- With pressing indicator

## Product Details

Product material	CrNiMo steel 1.4401 (DIN EN 10088)
Elbow	90°

## Scope Of Delivery

- Seal rings CIIR black

## Ordering Information

Article no.	dØ [mm]	R [°]	d1Ø [mm]	H [cm]	L [cm]	l [cm]	l1 [cm]	Z [cm]	Z1 [cm]
31454	15	1/2	15	3,4	6,4	3,2	3,2	1,2	1,2
31455	18	1/2	18	3,6	6,8	3,4	3,4	1,4	1,4
31458	22	3/4	22	4,2	7,4	3,7	3,7	1,6	1,6
31461	28	1	28	4,8	8,4	4,2	4,2	1,9	1,9
31464	35	1 1/4	35	5,4	10	5	5	2,4	2,4



## Adapters

### Geberit Mapress adapter with male thread

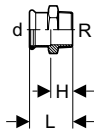

#### Application Purpose

- For sanitary and industrial applications
- For heating installations

#### Characteristics

- Male thread
- Leaky if unpressed
- With pressing indicator

#### Product Details

Product material	CrNiMo steel 1.4401 (DIN EN 10088)
------------------	------------------------------------

#### Scope Of Delivery

- Seal ring CIIR black

#### Ordering Information

Article no.	dØ [mm]	R ["]	H [cm]	L [cm]
31726	15	3/8	1,8	3,8
31703	15	1/2	2,1	4,1
31714	15	3/4	2,3	4,3
31704	18	1/2	2,2	4,2
31705	18	3/4	2,4	4,4
31715	22	1/2	2,1	4,2
31707	22	3/4	2,3	4,4
31716	22	1	2,5	4,6
31717	28	3/4	2,3	4,6
31708	28	1	2,3	4,8
31718	28	1 1/4	2,5	4,8
31719	35	1	2,5	5,1
31709	35	1 1/4	2,7	5,3
31720	35	1 1/2	2,7	5,3
31721	42	1 1/4	2,7	5,7
31710	42	1 1/2	2,7	5,7
31722	54	1 1/2	4,8	8,3
31711	54	2	5,4	8,9
31713	76,1	2 1/2	7	12,3
31724	88,9	3	7,7	13,7

### Geberit Mapress adapter with male thread NPT

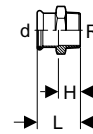

#### Application Purpose

- For sanitary and industrial applications
- For heating installations

#### Characteristics

- With pressing indicator
- Male thread NPT
- Leaky if unpressed

#### Product Details

Product material	CrNiMo steel 1.4401 (DIN EN 10088)
------------------	------------------------------------

#### Scope Of Delivery

- Seal ring CIIR black

#### Ordering Information

Article no.	dØ [mm]	R ["]	H [cm]	L [cm]
31833	15	1/2 NPT	2,8	4,8
31837	22	3/4 NPT	2,8	4,9
31838	28	1 NPT	3,1	5,6
31839	35	1 1/4 NPT	3,4	6
31840	42	1 1/2 NPT	3,5	6,5
31841	54	2 NPT	3,5	7

### Geberit Mapress adapter with male thread and plain end

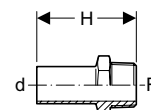

#### Application Purpose

- For sanitary and industrial applications
- For heating installations

#### Characteristics

- Male thread
- Plain end

#### Product Details

Product material	CrNiMo steel 1.4401 (DIN EN 10088)
------------------	------------------------------------

#### Ordering Information

Article no.	dØ [mm]	R ["]	H [cm]
31932	15	1/2	5,7
31933	18	1/2	5,7
31936	22	3/4	5,9
31937	28	1	6,6
31938	35	1 1/4	8
31939	42	1 1/2	9,1
31940	54	2	10,2

**Geberit Mapress adapter with female thread**

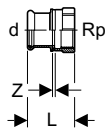

**Application Purpose**

- For sanitary and industrial applications
- For heating installations

**Characteristics**

- Female thread
- Leaky if unpressed
- With pressing indicator

**Product Details**

Product material	CrNiMo steel 1.4401 (DIN EN 10088)
------------------	------------------------------------

**Scope Of Delivery**

- Seal ring CIIR black

**Ordering Information**

Article no.	dØ [mm]	Rp ["]	L [cm]	Z [cm]
31802	15	1/2	3,7	0,4
31823	15	3/4	3,8	0,3
31803	18	1/2	3,7	0,4
31804	18	3/4	3,8	0,3
31805	22	1/2	3,6	0,2
31806	22	3/4	3,9	0,3
31824	22	1	4,2	0,4
31807	28	1/2	3,8	0,2
31819	28	3/4	3,9	0,3
31809	28	1	4,4	0,4
31825	28	1 1/4	4,6	0,4
31820	35	1	4,5	0,2
31811	35	1 1/4	4,9	0,4
31826	35	1 1/2	4,9	0,4
31821	42	1 1/4	5,1	0,2
31814	42	1 1/2	5,3	0,4
31822	54	1 1/2	7,1	2,2
31818	54	2	6,2	0,4

**Geberit Mapress adapter with female thread and plain end**

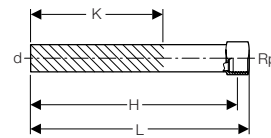
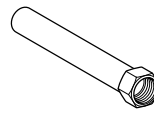

**Application Purpose**

- For sanitary and industrial applications
- For heating installations

**Characteristics**

- Female thread
- Plain end

**Product Details**

Product material	CrNiMo steel 1.4401 (DIN EN 10088)
------------------	------------------------------------

**Ordering Information**

Article no.	dØ [mm]	Rp ["]	H [cm]	L [cm]	K [cm]
90932	15	1/2	13,5	14,8	9
90933	18	1/2	13,5	14,8	9
90934	18	3/4	13,3	15,2	9
90935	22	1/2	13,9	14,8	8,9
90936	22	3/4	13,7	15,2	8,7

**Elbow adapters**

**Geberit Mapress elbow adapter 90° with male thread**

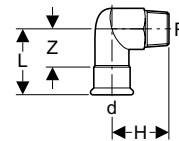

**Application Purpose**

- For sanitary and industrial applications
- For heating installations

**Characteristics**

- Male thread
- Leaky if unpressed
- With pressing indicator

**Product Details**

Product material	CrNiMo steel 1.4401 (DIN EN 10088)
Elbow	90°

**Scope Of Delivery**

- Seal ring CIIR black

**Ordering Information**

Article no.	dØ [mm]	R ["]	H [cm]	L [cm]	Z [cm]
33833	15	1/2	3,7	5,7	3,7
33834	18	1/2	3,9	5,7	3,7
33835	22	3/4	4,6	6	3,9
33836	28	1	5,4	6,7	4,4
33837	35	1 1/4	6,3	7,5	4,9
33838	42	1 1/2	6,7	8,3	5,3
33839	54	2	7,8	9,4	5,9



### Geberit Mapress elbow adapter 90° with female thread and plain end

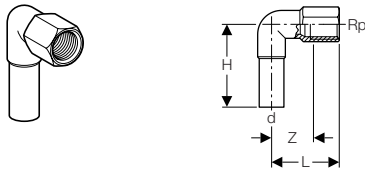

#### Application Purpose

- For sanitary and industrial applications
- For heating installations

#### Characteristics

- Female thread
- Plain end

#### Product Details

Product material	CrNiMo steel 1.4401 (DIN EN 10088)
Elbow	90°

#### Ordering Information

Article no.	dØ [mm]	Rp ["]	H [cm]	L [cm]	Z [cm]
33203	15	1/2	5,3	3,6	2,3

### Geberit Mapress elbow adapter 90° with female thread

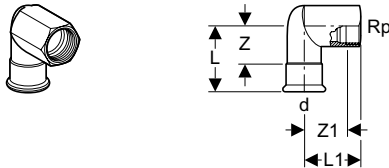

#### Application Purpose

- For sanitary and industrial applications
- For heating installations

#### Characteristics

- Female thread
- Leaky if unpressed
- With pressing indicator

#### Product Details

Product material	CrNiMo steel 1.4401 (DIN EN 10088)
Elbow	90°

#### Scope Of Delivery

- Seal ring CIIR black

#### Ordering Information

Article no.	dØ [mm]	Rp ["]	L [cm]	L1 [cm]	Z [cm]	Z1 [cm]
33803	15	1/2	5,7	3,7	3,7	2,4
33804	18	1/2	5,7	3,9	3,7	2,6
33805	22	3/4	6	4,6	3,9	3,1
33806	28	1	6,7	5,4	4,3	3,7
33807	35	1 1/4	7,5	6,3	4,9	4,4

## Connectors

### Geberit Mapress elbow tap connector 90°

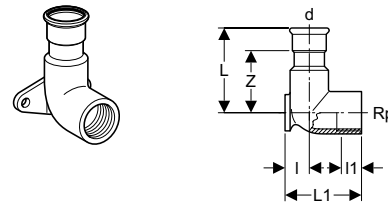

#### Characteristics

- Female thread
- Leaky if unpressed
- With pressing indicator

#### Product Details

Product material	CrNiMo steel 1.4401 (DIN EN 10088)
Elbow	90°

#### Scope Of Delivery

- Seal ring CIIR black

#### Ordering Information

Article no.	dØ [mm]	Rp ["]	L [cm]	L1 [cm]	I [cm]	I1 [cm]	Z [cm]
33403	15	1/2	5	4,3	1,3	1,5	3
33405	18	1/2	5	4,3	1,3	1,5	3
33407	22	3/4	5,4	5,1	1,7	1,6	3,3

### Geberit Mapress elbow tap connector 90°, offset

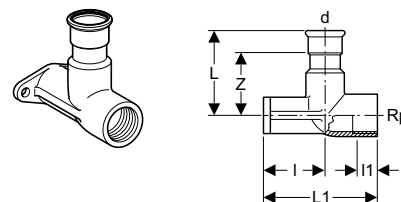

#### Application Purpose

- For preWall installation or larger wall distance

#### Characteristics

- Female thread
- Offset
- Leaky if unpressed
- With pressing indicator

#### Product Details

Product material	CrNiMo steel 1.4401 (DIN EN 10088)
Elbow	90°

#### Scope Of Delivery

- Seal ring CIIR black

#### Ordering Information

Article no.	dØ [mm]	Rp ["]	L [cm]	L1 [cm]	I [cm]	I1 [cm]	Z [cm]
33423	15	1/2	5	6,5	3,5	1,5	3
33425	18	1/2	5	6,5	3,5	1,5	3
33427	22	3/4	5,4	6,5	3,1	1,6	3,3

**Geberit Mapress corner elbow tap connector 90°**

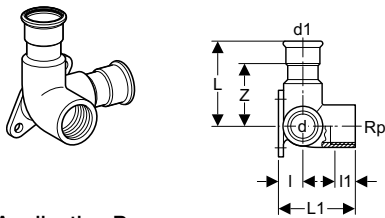

**Application Purpose**

- For flow-through hot water lines (TWW) or circulation connections (TWZ)

**Characteristics**

- Female thread
- Leaky if unpressed
- With pressing indicator

**Product Details**

Product material	CrNiMo steel 1.4401 (DIN EN 10088)
Elbow	90° / 90°

**Scope Of Delivery**

- Seal rings CIIR black

**Ordering Information**

Article no.	dØ [mm]	Rp ["]	d1Ø [mm]	L [cm]	L1 [cm]	I [cm]	I1 [cm]	Z [cm]
33503	15	1/2	15	6	4,3	1,3	1,5	4

**Adapter unions**

**Geberit Mapress adapter union with male thread**



**Application Purpose**

- For sanitary and industrial applications
- For heating installations

**Characteristics**

- Male thread
- Removable, flat seal
- Union nut made of brass
- Leaky if unpressed
- With pressing indicator

**Product Details**

Product material	CrNiMo steel 1.4401 (DIN EN 10088)
------------------	------------------------------------

**Scope Of Delivery**

- Seal ring CIIR black
- EPDM flat gasket

**Ordering Information**

Article no.	dØ [mm]	R ["]	G ["]	H [cm]	L [cm]
35330	15	1/2	3/4	4,4	6,4
35331	15	3/4	3/4	4,6	6,6
35332	18	1/2	3/4	4,4	6,4
35333	18	3/4	3/4	4,6	6,6

Article no.	dØ [mm]	R ["]	G ["]	H [cm]	L [cm]
35334	22	1/2	1	4,6	6,7
35335	22	3/4	1	4,7	6,8
35336	22	1	1	5,2	7,3
35337	28	1	1 1/4	5,5	7,8
35338	35	1 1/4	1 1/2	5,9	8,5
35339	42	1 1/2	1 3/4	6	9
35340	54	2	2 3/8	6,8	10,3

**Geberit Mapress adapter union with male thread, union nut made of stainless steel**

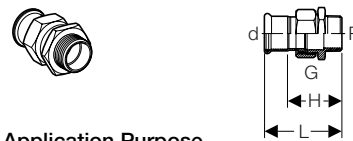

**Application Purpose**

- For sanitary and industrial applications
- For heating installations

**Characteristics**

- Male thread
- Removable, flat seal
- Union nut made of CrNi steel
- Leaky if unpressed
- With pressing indicator

**Product Details**

Product material	CrNiMo steel 1.4401 (DIN EN 10088)
------------------	------------------------------------

**Scope Of Delivery**

- Seal ring CIIR black
- EPDM flat gasket

**Ordering Information**

Article no.	dØ [mm]	R ["]	G ["]	H [cm]	L [cm]
35360	15	1/2	3/4	4,4	6,4
35361	15	3/4	3/4	4,6	6,6
35362	18	1/2	3/4	4,4	6,4
35363	18	3/4	3/4	4,6	6,6
35364	22	1/2	1	4,6	6,7
35365	22	3/4	1	4,7	6,8
35366	22	1	1	5,2	7,3
35367	28	1	1 1/4	5,5	7,8
35368	35	1 1/4	1 1/2	5,9	8,5
35369	42	1 1/2	1 3/4	6	9
35370	54	2	2 3/8	6,8	10,3



### Geberit Mapress adapter union with male thread and plain end

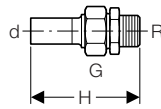

#### Application Purpose

- For sanitary and industrial applications
- For heating installations

#### Characteristics

- Male thread
- Removable, flat seal
- Plain end

#### Product Details

Product material	CrNiMo steel 1.4401 (DIN EN 10088)
------------------	------------------------------------

#### Scope Of Delivery

- EPDM flat gasket

#### Ordering Information

Article no.	dØ [mm]	R ["]	G ["]	H [cm]
35400	15	1/2	3/4	8,6
35402	18	1/2	3/4	8,6
35405	22	3/4	1	9,2
35407	28	1	1 1/4	10,1
35408	35	1 1/4	1 1/2	10,9
35409	42	1 1/2	1 3/4	11,5
35410	54	2	2 3/8	12,9

### Geberit Mapress adapter union with female thread

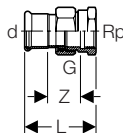

#### Application Purpose

- For sanitary and industrial applications
- For heating installations

#### Characteristics

- Female thread
- Removable, flat seal
- Union nut made of brass
- Leaky if unpressed
- With pressing indicator

#### Product Details

Product material	CrNiMo steel 1.4401 (DIN EN 10088)
------------------	------------------------------------

#### Scope Of Delivery

- Seal ring CIIR black
- EPDM flat gasket

#### Ordering Information

Article no.	dØ [mm]	Rp ["]	G ["]	L [cm]	Z [cm]
35300	15	1/2	3/4	5,9	2,6

Article no.	dØ [mm]	Rp ["]	G ["]	L [cm]	Z [cm]
35301	15	3/4	3/4	6,1	2,6
35302	18	1/2	3/4	5,9	2,6
35303	18	3/4	3/4	6,1	2,6
35304	22	3/4	1	6,3	2,7
35305	22	1	1	6,6	2,8
35306	28	1	1 1/4	7,1	3,1
35307	35	1 1/4	1 1/2	7,7	3,2
35308	42	1 1/2	1 3/4	8,2	3,3
35309	54	2	2 3/8	9,5	3,7

### Geberit Mapress adapter union with female thread, union nut made of stainless steel

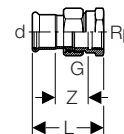

#### Application Purpose

- For sanitary and industrial applications
- For heating installations

#### Characteristics

- Female thread
- Removable, flat seal
- Union nut made of CrNi steel
- Leaky if unpressed
- With pressing indicator

#### Product Details

Product material	CrNiMo steel 1.4401 (DIN EN 10088)
------------------	------------------------------------

#### Scope Of Delivery

- Seal ring CIIR black
- EPDM flat gasket

#### Ordering Information

Article no.	dØ [mm]	Rp ["]	G ["]	L [cm]	Z [cm]
35350	15	1/2	3/4	5,9	2,6
35357	15	3/4	3/4	6,1	2,6
35351	18	1/2	3/4	5,9	2,6
35358	18	3/4	3/4	6,1	2,6
35352	22	3/4	1	6,3	2,7
35359	22	1	1	6,6	2,8
35353	28	1	1 1/4	7,1	3,1
35354	35	1 1/4	1 1/2	7,7	3,2
35355	42	1 1/2	1 3/4	8,2	3,3
35356	54	2	2 3/8	9,5	3,7

**Geberit Mapress adapter union with female thread and plain end**

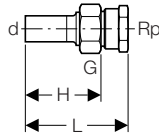

**Application Purpose**

- For sanitary and industrial applications
- For heating installations

**Characteristics**

- Female thread
- Removable, flat seal
- Plain end

**Product Details**

Product material	CrNiMo steel 1.4401 (DIN EN 10088)
------------------	------------------------------------

**Scope Of Delivery**

- EPDM flat gasket

**Ordering Information**

Article no.	dØ [mm]	Rp ["]	G ["]	H [cm]	L [cm]
35380	15	1/2	3/4	5,9	8,1
35382	18	1/2	3/4	5,9	8,1
35384	22	3/4	1	6,4	8,7
35386	28	1	1 1/4	6,7	9,4
35387	35	1 1/4	1 1/2	7,2	10,1
35388	42	1 1/2	1 3/4	7,7	10,7
35389	54	2	2 3/8	8,4	12

**Geberit Mapress adapter with stainless steel union nut**

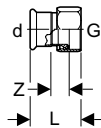

**Application Purpose**

- For sanitary and industrial applications
- For heating installations

**Characteristics**

- Union nut made of CrNi steel
- Flat sealed
- Leaky if unpressed
- With pressing indicator

**Product Details**

Product material	CrNiMo steel 1.4401 (DIN EN 10088)
------------------	------------------------------------

**Scope Of Delivery**

- Seal ring CIIR black
- EPDM flat gasket

**Ordering Information**

Article no.	dØ [mm]	G ["]	L [cm]	Z [cm]
35132	15	3/4	3,7	1,1
35134	22	1	4	1,1
35075	28	1 1/2	4,4	1,3

**Geberit Mapress adapter with union nut**

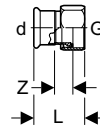

**Application Purpose**

- For sanitary and industrial applications
- For heating installations

**Characteristics**

- Union nut made of brass
- Flat sealed
- Leaky if unpressed
- With pressing indicator

**Product Details**

Product material	CrNiMo steel 1.4401 (DIN EN 10088)
------------------	------------------------------------

**Scope Of Delivery**

- Seal ring CIIR black
- EPDM flat gasket

**Ordering Information**

Article no.	dØ [mm]	G ["]	L [cm]	Z [cm]
35042	15	1/2	5,1	2,5
35032	15	3/4	3,7	1,1
35072	15	1 1/4	4,3	1,3
35033	18	3/4	3,7	1,1
35034	22	1	4	1,1
35044	22	1 1/4	4,3	1,3
35045	22	1 1/2	4,4	1,3
35046	28	1	4	1,3
35035	28	1 1/4	4,4	1,3
35047	28	1 1/2	4,8	1,3
35036	35	1 1/2	4,6	1,3
35037	42	1 3/4	5,2	1,3
35038	54	2 3/8	5,8	1,5
35039	76,1	3	10,1	3,3
35040	88,9	3 1/2	11,2	3,7



## Straight unions

### Geberit Mapress union

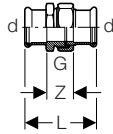

#### Application Purpose

- For sanitary and industrial applications
- For heating installations

#### Characteristics

- Removable, flat seal
- Union nut made of brass
- Leaky if unpressed
- With pressing indicator

#### Product Details

Product material	CrNiMo steel 1.4401 (DIN EN 10088)
------------------	------------------------------------

#### Scope Of Delivery

- Seal rings CIIR black
- EPDM flat gasket

#### Ordering Information

Article no.	dØ [mm]	G ["]	L [cm]	Z [cm]
35320	15	3/4	6,6	2,6
35321	18	3/4	6,9	2,9
35322	22	1	7,2	3
35323	28	1 1/4	7,7	3,1
35324	35	1 1/2	8,2	3
35325	42	1 3/4	9,5	3,5
35326	54	2 3/8	11,3	4,3

### Geberit Mapress union

new

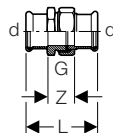

#### Application Purpose

- For sanitary and industrial applications
- For heating installations

#### Characteristics

- With pressing indicator
- Leaky if unpressed
- Removable, flat seal
- Union nut made of CrNi steel

#### Product Details

Product material	CrNiMo steel 1.4401 (DIN EN 10088)
Operating temperature with EPDM flat gasket	0–100 °C

#### Scope Of Delivery

- Seal rings CIIR black
- EPDM flat gasket

#### Ordering Information

Article no.	dØ [mm]	G ["]	L [cm]	Z [cm]
35390	15	3/4	6,6	2,6
35391	18	3/4	6,9	2,9
35392	22	1	7,2	3
35393	28	1 1/4	7,7	3,1
35394	35	1 1/2	8,2	3
35395	42	1 3/4	9,5	3,5
35396	54	2 3/8	11,3	4,3

## Flanges

### Geberit Mapress flange PN 10/16, with pressing socket

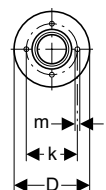
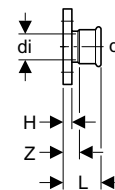

#### Application Purpose

- For sanitary and industrial applications
- For heating installations

#### Characteristics

- With pressing socket
- Leaky if unpressed
- With pressing indicator

#### Product Details

Product material	CrNiMo steel 1.4401 (DIN EN 10088)
------------------	------------------------------------

#### Scope Of Delivery

- Seal ring CIIR black
- Excluded: Set of bolts for flange
- Excluded: Flange gasket

#### Ordering Information

Article no.	dØ [mm]	diØ [mm]	D [cm]	k [cm]	m [cm]	H [cm]	L [cm]	Z [cm]	PN [bar]
33702	15	13	9,5	6,5	1,4	1,1	5,5	3,6	10 / 16
33703	18	16	9,5	6,5	1,4	1,1	5,7	3,7	10 / 16
33704	22	19,6	10,5	7,5	1,4	1,2	5,9	3,8	10 / 16
33705	28	25,6	11,5	8,5	1,4	1,4	6,5	4,2	10 / 16
33706	35	32	14	10	1,8	1,5	6,9	4,3	10 / 16
33707	42	39	15	11	1,8	1,6	7,7	4,7	10 / 16
33708	54	51	16,5	12,5	1,8	1,8	8,7	5,2	10 / 16
33709	76,1	72,1	18,5	14,5	1,8	1,8	12,6	7,3	10 / 16
33710	88,9	84,9	20	16	1,8	2	14,3	8,3	10 / 16
33711	108	104	22	18	1,8	2	16,8	9,3	10 / 16

**Geberit Mapress flange PN 10/16, with plain end**

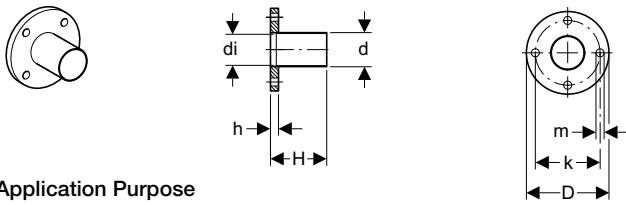

**Application Purpose**

- For sanitary and industrial applications
- For heating installations

**Characteristics**

- Plain end

**Product Details**

Product material	CrNiMo steel 1.4401 (DIN EN 10088)
------------------	------------------------------------

**Scope Of Delivery**

- Excluded: Set of bolts for flange
- Excluded: Flange gasket

**Ordering Information**

Article no.	dØ [mm]	diØ [mm]	D [cm]	k [cm]	m [cm]	H [cm]	h [cm]	PN [bar]
33728 <i>new</i>	54	54,5	16,5	12,5	1,8	8,7	1,8	10 / 16
33729	76,1	72,1	18,5	14,5	1,8	12,6	1,8	10 / 16
33730	88,9	84,9	20	16	1,8	14,3	2	10 / 16
33731	108	104	22	18	1,8	16,8	2	10 / 16

**Geberit Mapress flanged stub with plain end, for loose flange PN 6**

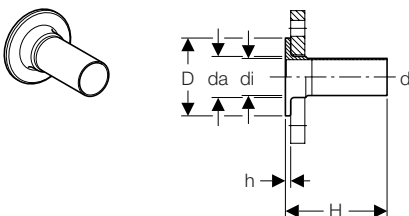

**Application Purpose**

- For loose flange

**Characteristics**

- Plain end

**Product Details**

Product material	CrNiMo steel 1.4401 (DIN EN 10088)
------------------	------------------------------------

**Scope Of Delivery**

- Excluded: Loose flange
- Excluded: Set of bolts for flange
- Excluded: Flange gasket

**Ordering Information**

Article no.	dØ [mm]	da [mm]	diØ [mm]	D [cm]	H [cm]	h [cm]	PN [bar]
36150	28	32	25,6	6	13,5	0,6	6
36151	35	40	32	7	13,5	0,6	6
36152	42	47	39	8	13,5	0,6	6
36153	54	59	51	9	13,5	0,8	6
36154	76,1	78	73,1	11	13,5	0,8	6
36155	88,9	91	84,9	12,8	13,5	1	6
36156	108	110	104	14,8	13,5	1	6

**Geberit Mapress flanged stub with plain end, for loose flange PN 10/16**

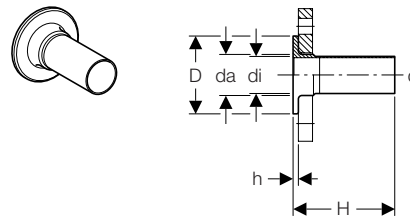

**Application Purpose**

- For loose flange

**Characteristics**

- Plain end

**Product Details**

Product material	CrNiMo steel 1.4401 (DIN EN 10088)
------------------	------------------------------------

**Scope Of Delivery**

- Excluded: Loose flange
- Excluded: Set of bolts for flange
- Excluded: Flange gasket

**Ordering Information**

Article no.	dØ [mm]	da [mm]	diØ [mm]	D [cm]	H [cm]	h [cm]	PN [bar]
36141	22	27	19,6	5,8	13,5	0,6	10 / 16
36142	28	32	25,6	6,8	13,5	0,6	10 / 16
36143	35	40	32	7,8	13,5	0,6	10 / 16
36144	42	47	39	8,8	13,5	0,6	10 / 16
36145	54	59	51	10,2	13,5	0,8	10 / 16
36146	76,1	78	72,1	12,2	13,5	0,8	10 / 16
36147	88,9	91	84,9	13,8	13,5	1	10 / 16
36148	108	110	104	15,8	13,5	1	10 / 16



### Expansion fittings

#### Geberit Mapress axial expansion fitting with pressing sockets

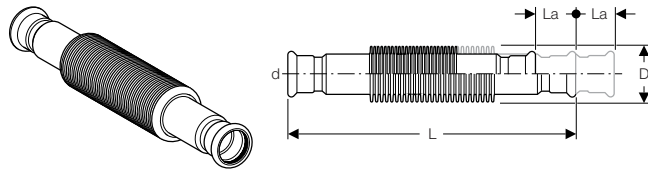

#### Characteristics

- Leaky if unpressed

#### Scope Of Delivery

- Seal rings CIIR black

#### Ordering Information

Article no.	dØ [mm]	D [cm]	La [cm]	L [cm]
33922	15	2,7	0,7	15,1
33923	18	2,7	0,7	14,7
33924	22	3,5	1,1	10,6
33925	28	4,2	1	12
33926	35	4,2	1	13,9
33927	42	5,6	1,1	14,9
33928	54	7,2	1,4	17,6
33929	76,1	9,4	2,2	26,2
33930	88,9	10,5	2,3	28,6
33931	108	13,6	2,3	54,2

### Mapress stop valves

#### Geberit Mapress straight seat stop valve

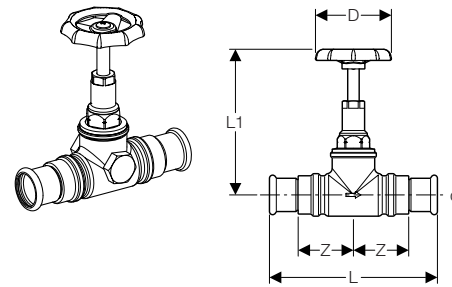

#### Application Purpose

- For drinking water installations

#### Characteristics

- No dead space, valve completely scoured out
- Pressing sockets
- Maintenance-free spindle seal with self-lubricating lip seal EPDM
- Valve seal PTFE with stainless steel seat
- Valve body of gunmetal
- Upper part of brass

#### Product Details

Operating temperature	0–90 °C
-----------------------	---------

#### Scope Of Delivery

- Hand wheel set

#### Ordering Information

Article no.	dØ [mm]	D [cm]	L [cm]	L1 [cm]	Z [cm]	PN [bar]
94862	15	6	13	10,5	4,5	16
94863	18	6	13,2	10,5	4,6	16
94864	22	6	14,2	10,9	5	16
94865	28	7	15,8	13,7	5,6	16
94866	35	7	17,2	16,2	6	16

### Geberit Mapress angle seat stop valve

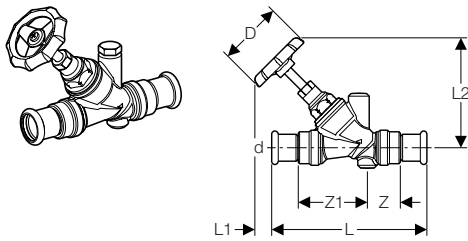

#### Application Purpose

- For drinking water installations

#### Characteristics

- No dead space, valve completely scoured out
- Pressing sockets
- Maintenance-free spindle seal with self-lubricating lip seal EPDM
- Valve seat of stainless steel
- Valve body of gunmetal
- Upper part of brass

#### Product Details

Operating temperature	0–90 °C
-----------------------	---------

#### Scope Of Delivery

- Hand wheel set

#### Ordering Information

Article no.	dØ [mm]	D [cm]	L [cm]	L1 [cm]	L2 [cm]	Z [cm]	Z1 [cm]	PN [bar]
94882	15	6	9,4	3,7	9	1,5	3,9	16
94883	18	6	9,5	3,3	9	1,1	4,5	16
94884	22	6	10,9	3,2	10,5	2,2	4,5	16
94885	28	7	13	4,4	13,2	2,1	6,3	16
94886	35	7	15,1	5,6	15,4	2,9	7	16
94887	42	7	17,8	4,3	16,2	3	8,8	16
94888	54	9	21,4	5,5	19,3	4,4	10	16

### Geberit emptying valve

new

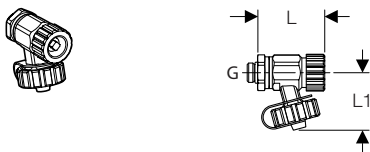

#### Application Purpose

- For straight seat and angle seat stop valves

#### Product Details

Product material	Gunmetal
------------------	----------

#### Ordering Information

Article no.	G ["]	L [cm]	L1 [cm]
241.576.00.1	1/4	4,5	3,5

### Geberit Mapress concealed stop valve with cover collar

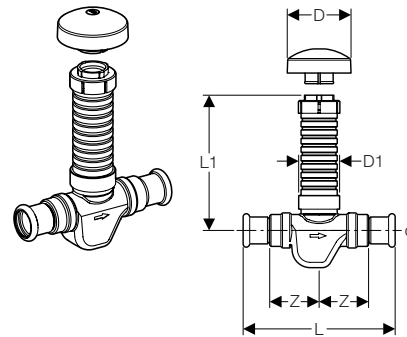

#### Application Purpose

- For drinking water installations

#### Characteristics

- No dead space, valve completely scoured out
- Pressing sockets
- With stop, regulate and preset function
- Maintenance-free spindle seal
- Valve seal EPDM
- Installation depth up to 10 cm
- Protection box, can be shortened

#### Product Details

Operating temperature	0–90 °C
Product material	Gunmetal

#### Scope Of Delivery

- Rosette with end cap

#### Ordering Information

Article no.	dØ [mm]	D [cm]	D1 [cm]	L [cm]	L1 [cm]	Z [cm]	PN [bar]
94902	15	7	3,9	14	11	4,92	16
94903	18	7	3,9	14	11	5,05	16
94904	22	7	3,9	14,5	11	5,05	16
94905	28	7	4,6	18	11,5	6,8	16



### Ball valves

#### Geberit Mapress ball valve, with lever

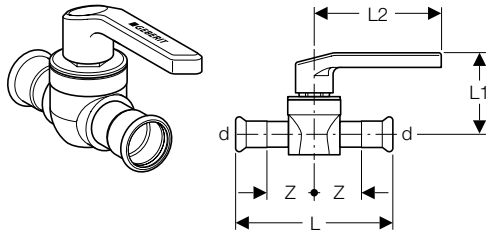

#### Application Purpose

- For drinking water installations

#### Characteristics

- Leaky if unpressed
- Ball and spindle made of brass, PTFE-coated
- No dead space, valve completely scoured out
- Valve top replaceable

#### Product Details

Operating temperature	-20 – +90 °C
Product material	CrNiMo steel 1.4401 (DIN EN 10088)

#### Scope Of Delivery

- Seal rings CIIR black
- Colour codes (red, blue)

#### Ordering Information

Article no.	dØ [mm]	L [cm]	L1 [cm]	L2 [cm]	Z [cm]	PN [bar]
94942	15	10,2	5,8	9,2	3,1	16
94943	18	10,4	5,8	9,2	3,2	16
94944	22	11,6	6,1	9,2	3,7	16
94945	28	13,4	7,2	12,4	4,4	16
94946	35	15,4	7,6	12,4	5,1	16
94947	42	17,7	8,3	14,7	5,9	16
94948	54	20,6	8,8	14,7	6,8	16

### Bulkhead and deck passings

#### Geberit Mapress bulkhead and deck passing with plain ends

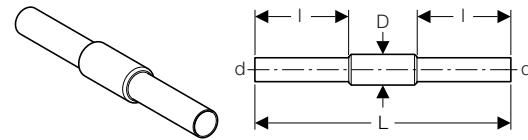

#### Application Purpose

- To weld into ship bulkheads

#### Product Details

Product material	CrNiMo steel 1.4401 (DIN EN 10088)
------------------	------------------------------------

#### Ordering Information

Article no.	dØ [mm]	L [cm]	I [cm]
90980	15	45	16,5
90981	18	45	16,5
90982	22	45	16,5
90983	28	45	16,5
90984	35	45	16,5
90985	42	45	16,5
90986	54	45	16,5
90987	76,1	45	16,5
90988	88,9	45	16,5
90989	108	45	16,5

### Closures

#### Geberit Mapress cap

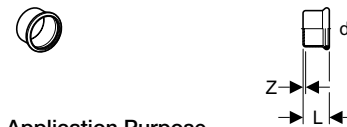

#### Application Purpose

- For sanitary and industrial applications
- For heating installations
- For closing pipe ends

#### Characteristics

- Leaky if unpressed
- With pressing indicator

#### Product Details

Product material	CrNiMo steel 1.4401 (DIN EN 10088)
------------------	------------------------------------

#### Ordering Information

Article no.	dØ [mm]	L [cm]	Z [cm]
33212	15	2,3	0,3
33213	18	2,3	0,3
33214	22	2,4	0,3
33215	28	2,6	0,3
33216	35	2,9	0,3
33217	42	3,3	0,3
33218	54	3,8	0,3
33219	76,1	6	0,7
33220	88,9	6,7	0,7
33221	108	8,2	0,7